

1942?



LABORATORY INSTRUMENTS

For Speed and Accuracy

HEWLETT-PACKARD COMPANY

395 PAGE MILL ROAD • PALO ALTO • CALIFORNIA

HALF BAND WIDTH

40 DB

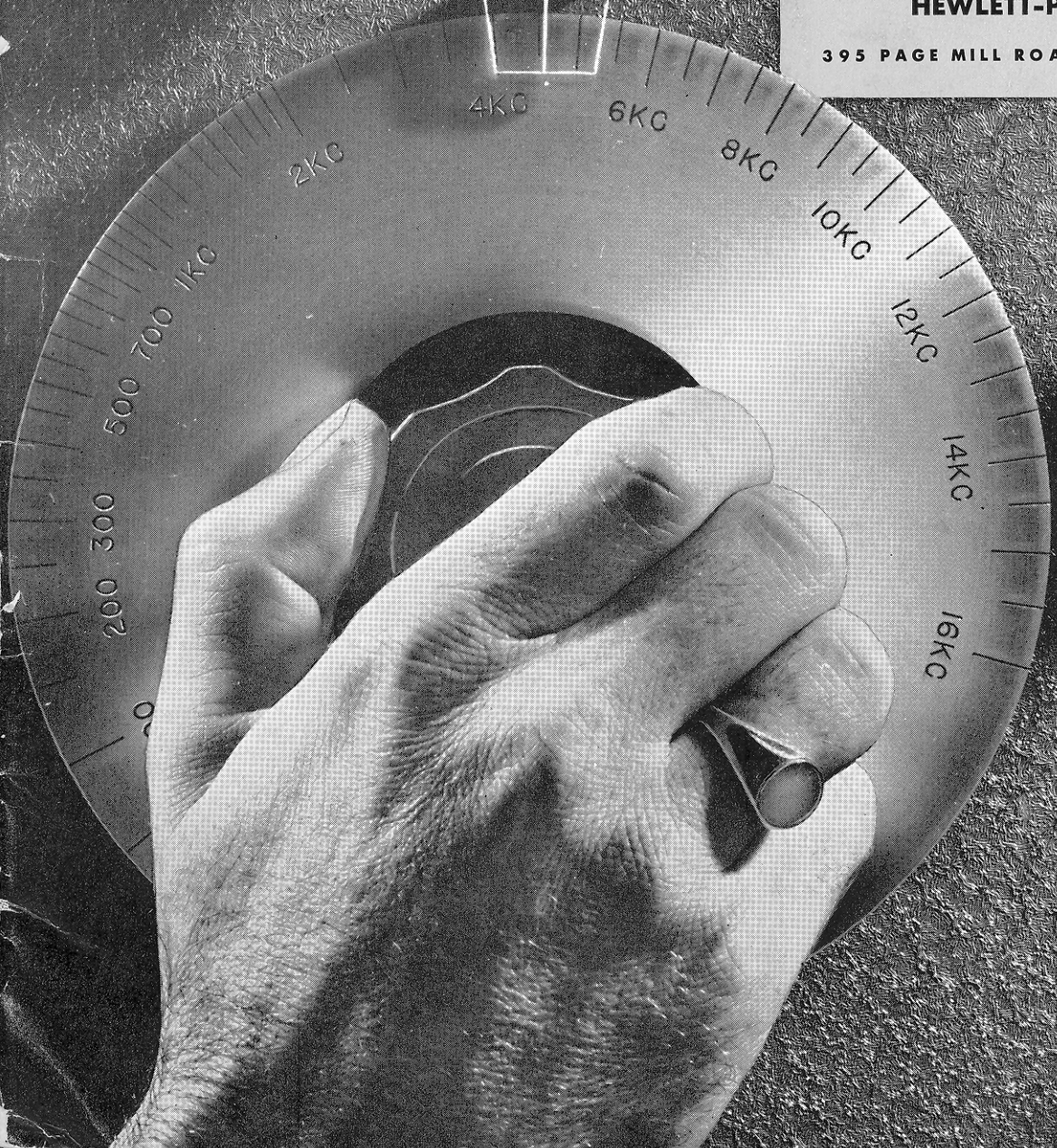
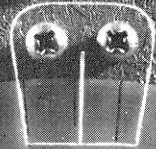
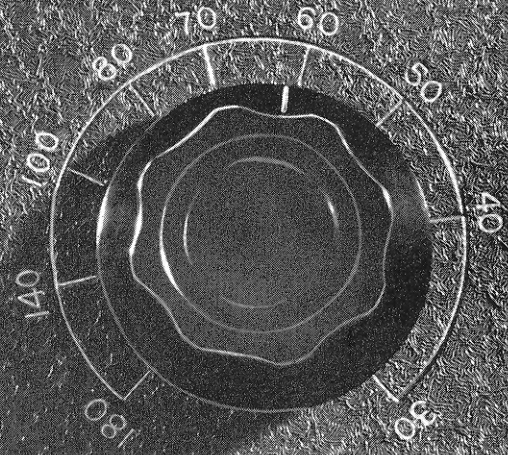



IMPORTANT MANUFACTURERS
and **LABORATORIES** such as these
depend upon

hp

Laboratory and Production Instruments

The acceptance of *-hp-* Instruments by many of the leading industrialists and research men throughout the country offer adequate testimony as to their dependability, and usefulness. A few examples are shown below:

Galvin Manufacturing Company, makers of the famous Motorola radio equipment, find *-hp-* instruments extremely useful in checking performance of these well-known products. In service at this factory is a Model 300A Harmonic Wave Analyzer and a Model 205A Audio Signal Generator.

The Rockola Manufacturing Company uses an *-hp-* 205AG Audio Signal Generator and 320A Distortion Analyzer to check the audio equipment used in the Automatic Phonographs they manufacture.

Brush Development Company uses an *-hp-* Resistance Tuned Oscillator to check the AF performance of the Self Inking Oscillographs chart as low frequency electrical fluctuations with as little as .001 volt input. Such an instrument requires accurate testing and the *-hp-* oscillator does an important job.

One after another leading manufacturers and laboratories are putting *-hp-* instruments to work. These time and money savers are paying dividends to owners by providing accurate, high-speed tests and measurements on production lines and in development work.



RESearch into the fields of electrical engineering, physics, chemistry and all phases of science is greatly aided by the use of modern electronic measuring devices. The accuracy with which measurements are made is the yardstick of progress. Time is always an important element. Thus, electronic instruments should combine speed of operation with accuracy. It was with this idea in mind that *-hp-* instruments were developed. In all *-hp-* instruments the accent is on speed combined with accuracy. Speed is obtained by simplicity of operation—accuracy by advanced design and construction.

On the following pages is a comprehensive description of the *-hp-* instruments which are now in use by leading organizations throughout the country. Continual engineering and research in the *-hp-* laboratory is resulting in newer developments and additional instruments to answer the increasing number of problems encountered in the field of electronic research and production.

Revolutionary Resistance-Tuned Principle

*Provides Audio Frequency Oscillators
With Many Outstanding Advantages*

THE purpose of an Audio Oscillator is to generate a stable signal which can be accurately controlled. This signal is used to check the performance of audio amplifiers, broadcast transmitters and other equipment. Minimum of distortion, low thermal drift and constant output over a wide frequency range are attributes which such instruments should possess.

The *-hp-* Resistance-Tuned Audio Oscillator utilizes a network of resistors through which regeneration is supplied. The effective "Q" of this network is maintained in a high order by the negative feedback in the amplifier so that the frequency is stable. Fundamentally the Resistance-Tuned Oscil-

lator is much more stable and produces less distortion than the common types of variable frequency audio oscillators on the market today. Low temperature coefficient elements in the resistance network keeps thermal drift at the very minimum. Furthermore, this thermal drift is not magnified as is the case with the beat frequency oscillator.

A unique balancing circuit automatically selects the proper operating point for the oscillator and keeps the distortion at a low level at all times. Thus no manual adjustment of the operating point is necessary. The principles of this new development by the Hewlett-Packard Company are disclosed in U. S. Patent No. 2268872.

4

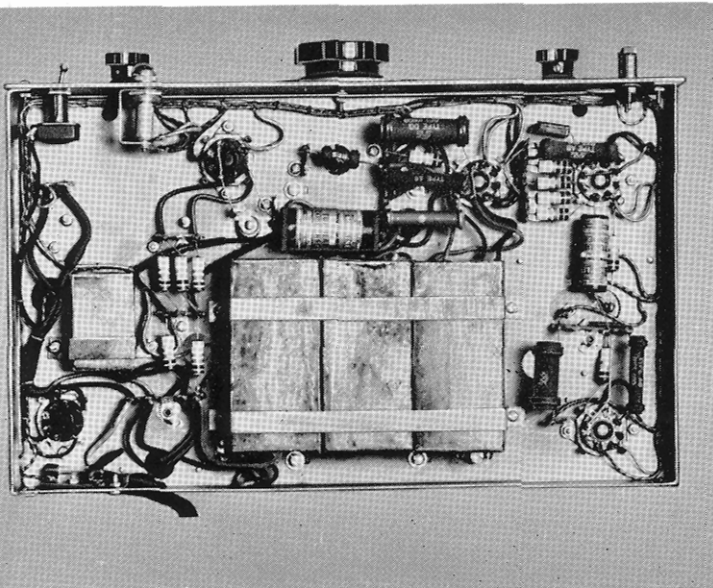

Relatively few circuit elements are required in these oscillators. View above is of sub-chassis. Note the clean-cut arrangement of the elements and simplicity of wiring in the view of the sub-chassis above.

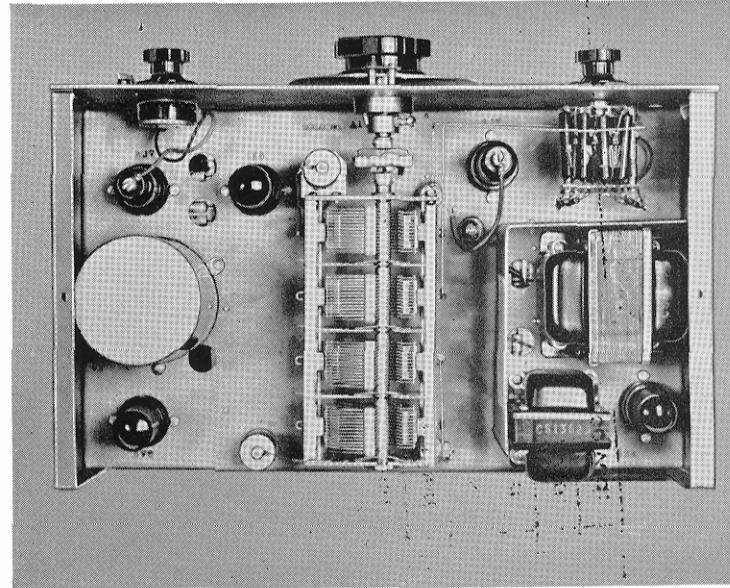

Thermal drift is kept at a minimum by low temperature co-efficient elements in the resistance network. The frequency is tuned over a 10 to 1 range by means of the variable condenser. The range is multiplied by selection of the proper resistor with the panel switch.



The *-hp-* Resistance-Tuned principle is excellent for many special purposes. The frequency can be extended several decades to the lower radio frequency range. Because the frequency is stable over long periods, *-hp-* resistance-tuned oscillators are ideal for operation at very low frequencies. Special problems in audio or super-sonic oscillators will be given careful attention and the proper instrument developed to meet your need. Standard Model 200C [above] has a frequency range of 20 cps to 200 kc.

5

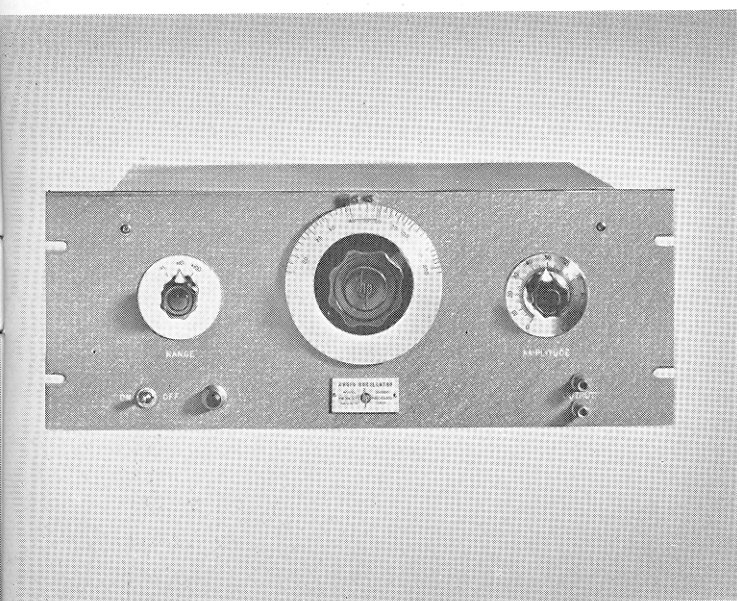

All *-hp-* instruments are available for relay rack mounting as well as in cabinet models. Above is Model 200BR resistance tuned Audio Oscillator for relay rack.

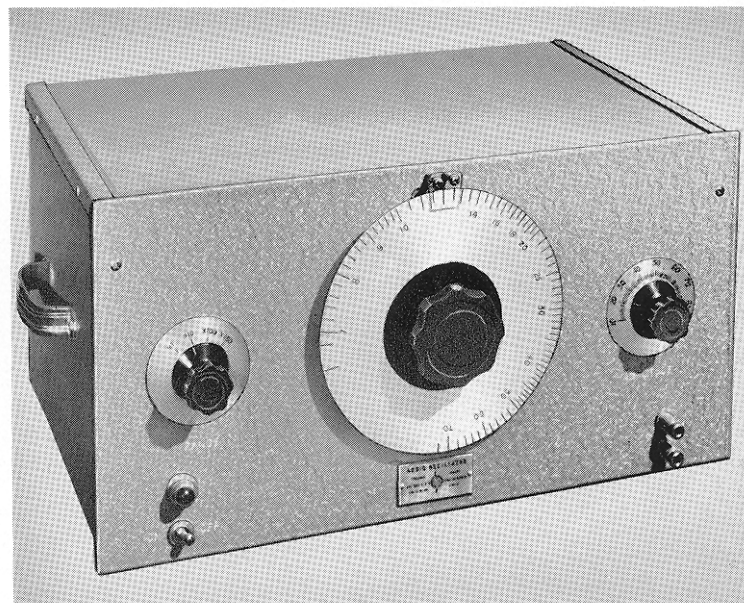

Special instruments can be supplied in many cases to meet your exact requirements. Above oscillator a special No. 200D delivers frequencies from 2 cps to 70 kc with a nearly constant output voltage.

SIMPLICITY is

-hp- Instruments are as Revolutionary

TO GAIN speed of operation without sacrifice of accuracy, all -hp- instruments are designed to operate with a minimum of adjustment. For the first time a variable frequency audio frequency oscillator which does not require a zero adjustment is available. The -hp- vacuum tube voltmeter is as simple to operate as a multi-range d-c instrument.



A Model 205AG is connected to measure the gain of an amplifier.



Model 400A is being used for measurements on a Radio Compass.

Below: A Model 205AG is being used on a research project at the Stanford University Communications Laboratory.



The use of audio oscillators is not by any means limited to the electrical engineering field. One interesting application of -hp- Resistance-Tuned Oscillators is in the determination of Young's Modulus of samples of concrete. In this measurement the output of the oscillator is connected to a magnetic driver to which the concrete sample is secured. The oscillator frequency is adjusted to determine the resonate frequency of the sample. From this measurement and other data, the characteristics of the concrete are determined.

Of course, the large group of applications for -hp- oscillators is in communications and electronic fields, where the use and importance of an audio oscillator is well known. Various oscillators have been designed to meet specific requirements generally encountered in this field.

Curve below shows the output voltage versus frequency on the model 200C. Note that the frequency response is under ± 1 DB over 4 decades.

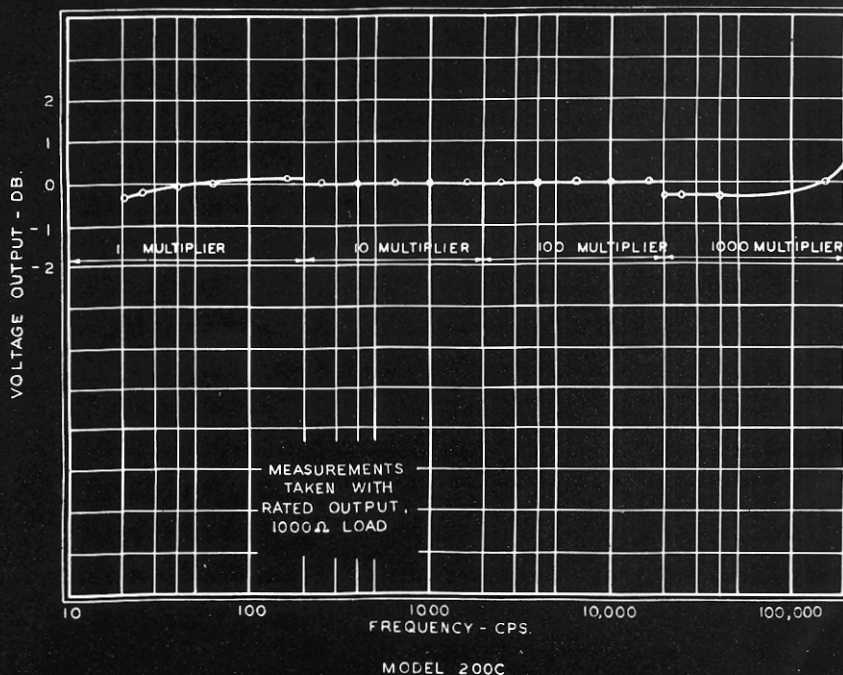

the KEYNOTE

Keynote as the One-Dial Radio Receiver

Another method -hp- uses to increase the speed of measurement work is to provide equipment to do the complete job all in one cabinet. The Model 205AG is a good example of this all-in-one combination of instruments. This instrument incorporates a resistance-tuned audio oscillator, input meter, output meter, attenuator and impedance matching system . . . all in a single unit.

The fact that -hp- Resistance-Tuned Oscillators are very stable makes them particularly suitable for frequency measurements at the lower frequencies. In certain applications it is important to have the resonate frequency of speaker cones fall within a very narrow band. Many -hp- oscillators are made for measurements of this type because the frequency calibrations can be depended upon over long periods. With these instruments the inconvenience of continuously re-adjusting to zero beat is avoided.

In checking frequency of mechanical equipment, these oscillators are invaluable. Such measurements include a wide range of application from measurements of natural vibration of mechanical parts to the measurements of output frequency of rotating equipment, such as generators and dynamotors.

Curve below shows total harmonic distortion vs. frequency on the Model 200C. Note that the distortion is well below 1% over the entire range.

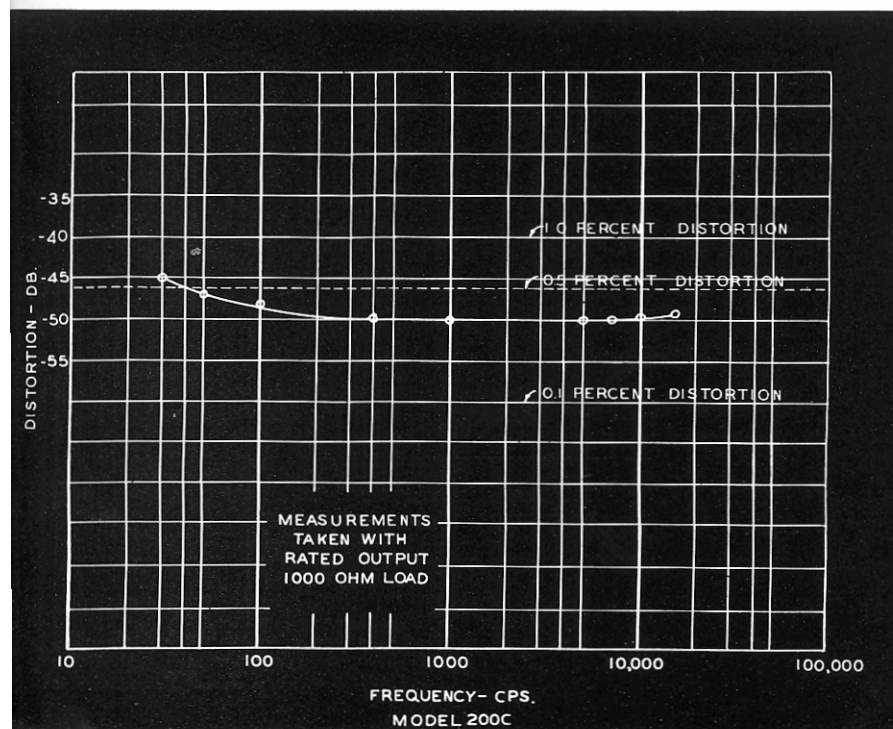

This Model 200B oscillator is being used to check the resonate frequency of a speaker.



Frequency of the output voltage of a dynamotor is being measured with a Model 200B.

Below: Models 205AG and 300A make an ideal combination for general laboratory use.



For Distortion Measurements

TWO types of *-hp-* instruments are available for distortion measurements, the 300A and 320 series. Model 300A is a tuned voltmeter and its primary purpose is to measure the individual components of a complex wave. This instrument is also useful in analyzing vibration components in a mechanical system. It is useful in making performance measurements on wave filters and in many other applications where the exact voltage of a particular frequency is to be measured.

Where measurements of the total harmonic distortion present are required, the 320 Distortion Analyzer provides a simple and direct answer. These analyzers are most useful instruments in development work on audio frequency systems. When used in combination with an oscilloscope, a direct picture of distortion components can be obtained while circuit changes are being made. Where the problem is production testing, these analyzers provide the quickest means for making distortion measurements.

8



Model 300A Wave Analyzer being used to measure the individual harmonics present in the output voltage of an amplifier.

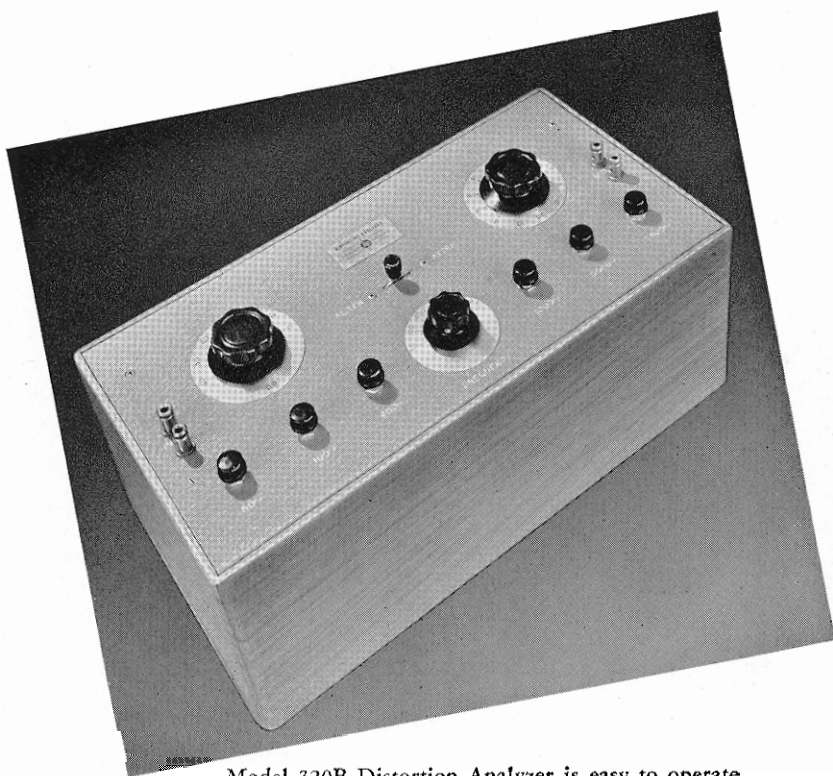

Model 320B Distortion Analyzer is easy to operate and provides a rapid and accurate check of distortion in audio frequency apparatus.



The 325B Distortion Analyzer is being used to measure the total harmonic distortion of a Model 200B on the production test bench.

The Square Wave Method

ONE of the most recent approaches to the problem of measuring the response of amplifiers and networks is to apply a square wave voltage and observe shape of the wave which is transmitted. A sharp wavefront contains a large number of frequencies. This wavefront is distorted when all of the frequencies originally present are not transmitted. The frequencies contained in a uniform square wave are given by the relation:

$$f(t) = \frac{4}{\pi} (\sin wt + \frac{1}{3} \sin 3 wt + \frac{1}{5} \sin 5 wt + \dots)$$

In practice a wave which appears to be perfectly square will contain thirty harmonics or more and when the amplitude or phase relation of the harmonics is disturbed the square wave will be distorted.

Thus the application of a square wave to a circuit shows up any irregularities in the amplitude or phase transmission of that circuit not only at the square wave frequency but also at frequencies far removed from the test point.

Because a square wave observation will indicate circuit performance over a wide frequency range in one observation, it is a very important test to use with other standard point by point measurements which are often not sufficient alone.

The square wave test is particularly important in feedback circuits where the circuit performance outside the normal transmission band is generally of interest. The application of a square wave test to a feedback amplifier will show in a single observation whether the amplifier is close to the oscillation point.

Both as a general purpose instrument for laboratory work and as a time saver in production testing a square wave generator is an important instrument in the electronic field.

The *-hp-* model 210 Square Wave Generator provides an excellent square wave and is more useful than other instruments of this type because the frequency can be accurately set for quantitative measurements of decrement factor, time and other quantities in transient analysis.



Square Wave Distortion from poor high frequency response.

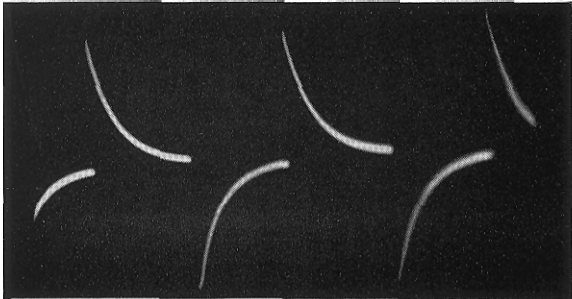

Square Wave Distortion from poor low-frequency sponse. (Phase shift of low frequency components wh always accompanies cut-off.)



Square Wave Distortion from poor response at both low and high frequency. (A typical amplifier oscillogram.)

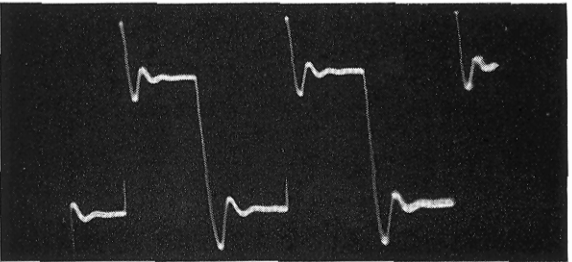

Square Wave test on a feedback amplifier showing amplification peak at 9 times square wave frequency. A normal frequency response measurement shows flat response from 20 cps to 20KC.)

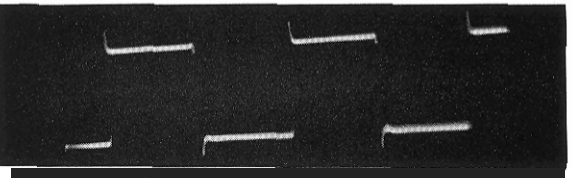

Attenuator leakage at high frequencies shows up in this oscillogram.

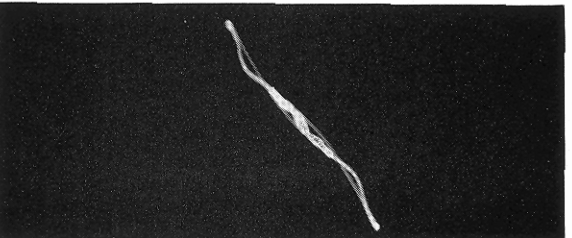

Square wave applied to two amplifiers, output of one on horizontal plates, output of other vertical plates for rapid comparison test. Nearly straight line obtained when amplifiers have nearly identical characteristics.

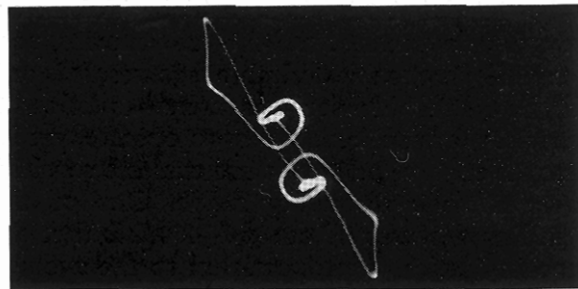

Same as left. One amplifier defective shows up immediately whereas without square wave a long point by point frequency response would be required to discover deviation from standard.

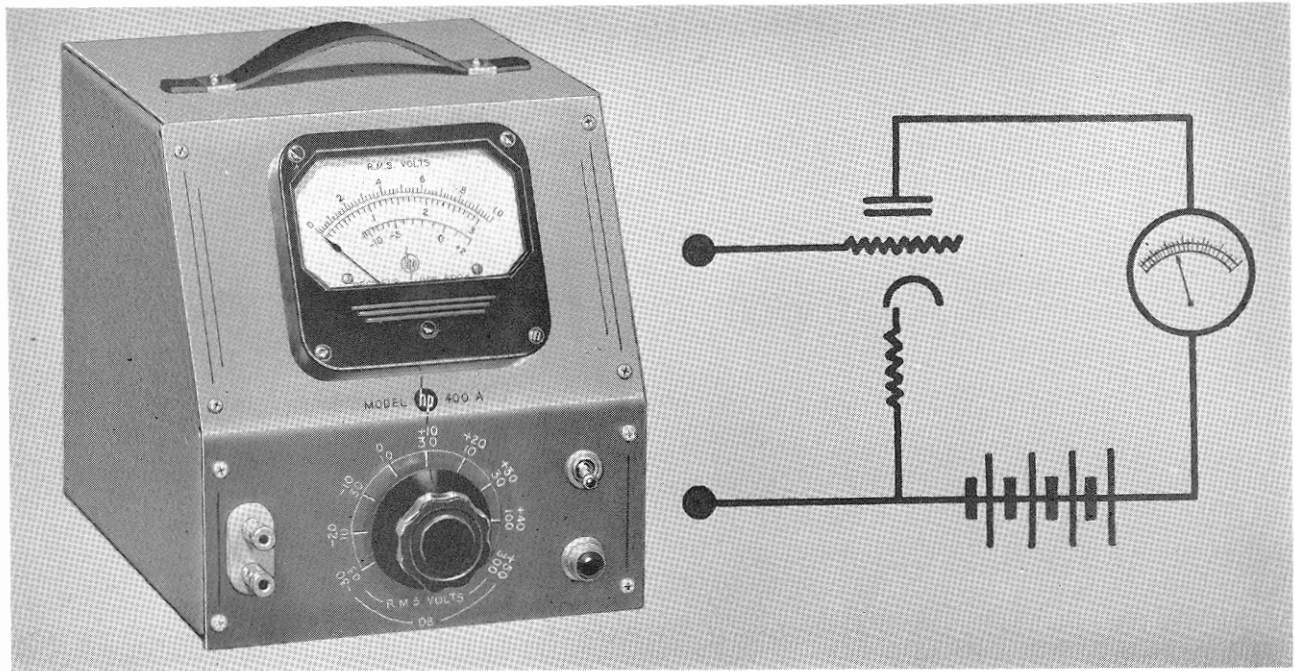

Accurate Voltage Measurement

OF the many electronic instruments, one of the most useful is the Vacuum Tube Voltmeter. There are many types available today, most of which have certain important features in common, two of which are . . . high input impedance and wide frequency response.

High input impedance is a feature not obtainable in an ordinary A. C. voltmeter. This important characteristic is obtainable in an electronic voltmeter. It enables one to measure voltage without disturbing the current under test. The wide frequency response which can be obtained makes it possible to measure voltage at high frequencies with good accuracy. High sensitivity and good accuracy are other characteristics highly desirable for laboratory and production work.

The *-hp-* Model 400A Vacuum Tube Voltmeter, a recent development of the *-hp-* laboratories, possesses all the important desirable features. It is one of the best available for measurements below 1 megacycle.* It is extremely easy to operate, yet its accuracy is unexcelled and it has extreme sensitivity over a wide frequency range. One of the outstanding features of the *-hp-* 400A is that the voltage indication is proportional to the average value of the full wave. This is a feature not found in most electronic meters on the market today.

*At frequencies above 1 megacycle the diode voltmeter is generally satisfactory. If properly designed it will provide good accuracy to 100 mc, but with some sacrifice of sensitivity.



The 400A is unexcelled for production applications such as these shown; where accurate high frequency measurements can be made without particular precautions.



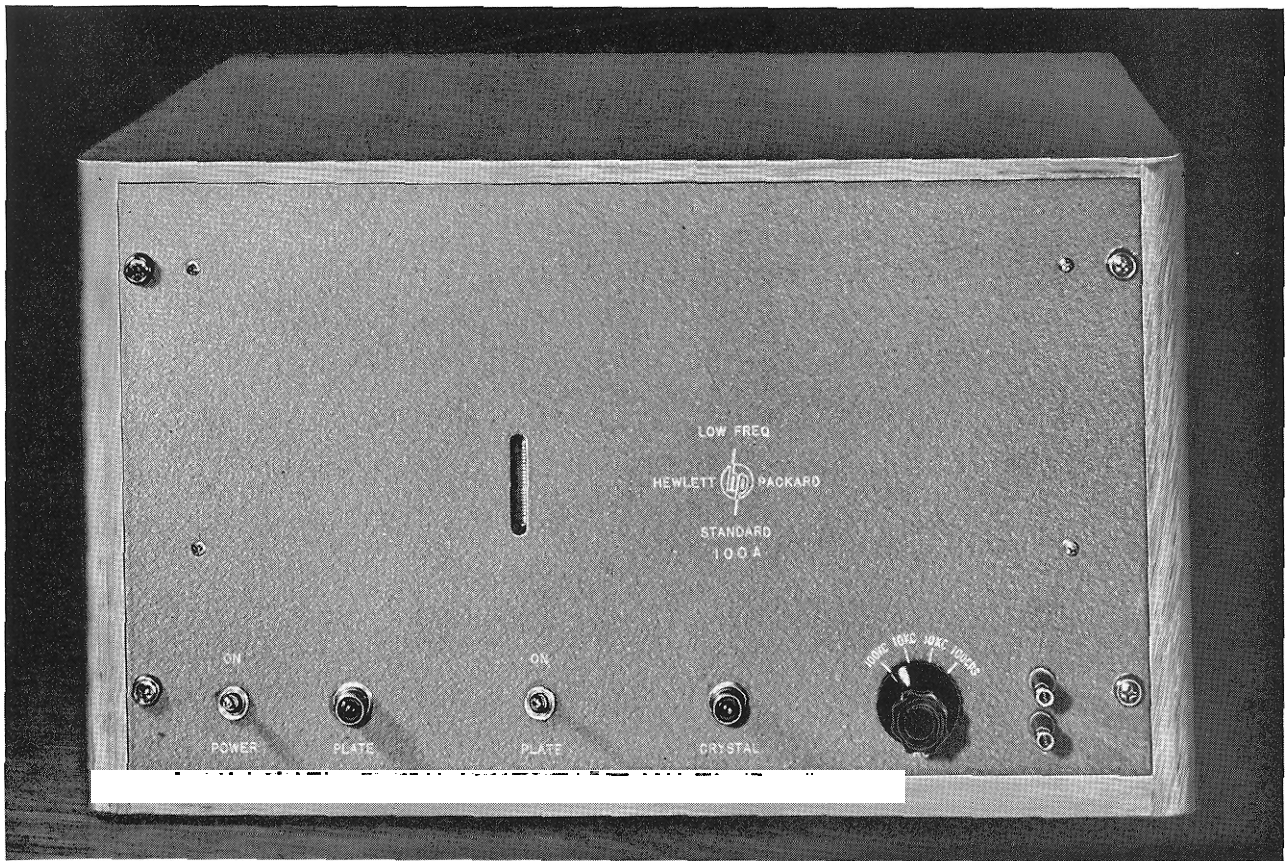

MODEL 100A



SECONDARY FREQUENCY STANDARD

- *Supplies Standard Frequencies of 100 CPS, 1000 CPS, 10,000 CPS and 100,000 CPS.*
- *Standard Frequencies available simultaneously*
- *Available either with or without temperature control*

 The Model 100A Low Frequency Standard provides a convenient and extremely useful source of standard frequencies from 100 cps to 100 kc. In the laboratory it provides standard frequencies for accurate measurement purposes, for calibrating audio equipment such as oscillators and frequency meters, and for various other work where better accuracy than is provided by the usual audio oscillator is required. It is useful in making accurate interpolation measurements at higher frequencies where it can be used to standardize such measurements to a high degree. In production test work this standard is unexcelled because a single unit can be used to provide standard frequencies at a number of test positions. **DESCRIPTION:** The Model 100A consists of a crystal controlled oscillator and a series of frequency dividers of the regenerative modulator type to provide standard frequencies of 100 kc, 10 kc, 1 kc, and 100 cps. The output of

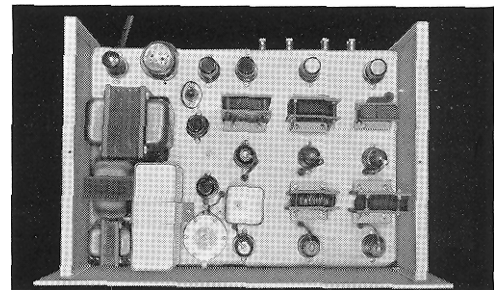

Views showing component parts on top and bottom of chassis.

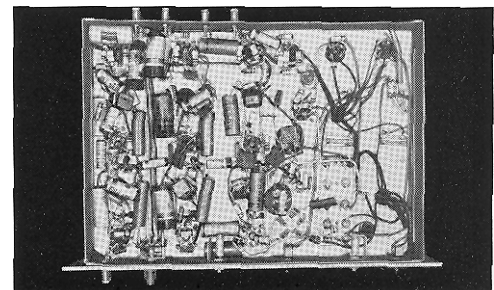

each frequency divider is available separately through a low impedance output system. There are two advantages of the regenerative modulator type of frequency divider over the multi-vibrator system which has been commonly used: first, the output wave shape is sinusoidal so that Lissajou patterns can be conveniently used even for high fractional ratios, and second, this frequency divider is more stable in operation. The output system is designed to isolate each frequency. The internal impedance of the output system is sufficiently low to permit the use of long lengths of low capacity shielded cable to distribute the standard frequencies in the laboratory or test department. Separate terminals are provided for each frequency and also a common set of output terminals is supplied with a selector switch.

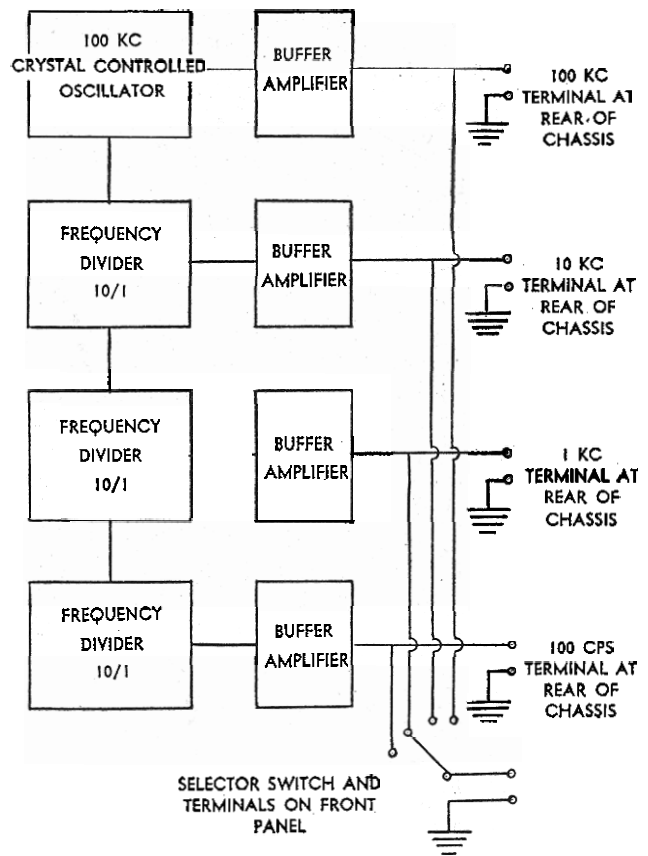

SPECIFICATIONS

ACCURACY: In the standard instrument a 100 kc crystal having a temperature coefficient of 3 cps per megacycle per degree centigrade is provided. The crystal oscillator is arranged so that the frequency can be adjusted over a range of approximately plus or minus 8 cps at 100 kc. This allows the frequency to be set to a primary standard such as WWV where an exact calibration is required. The frequencies are correct within plus or minus .01% over a room temperature variation of plus or minus 33 degrees centigrade. Where better accuracy is desired a temperature controlled crystal can be provided to hold the frequency within plus or minus .001% from minus 10 degrees centigrade to plus 50 degrees centigrade.

OUTPUT: An output voltage of at least 5 volts is provided on all frequencies into an impedance of 500 ohms or higher. The internal impedance of the output system is approximately 200 ohms and satisfactory wave shape can be obtained with a load impedance as low as 1000 ohms.

WAVE SHAPE: The output wave shape is sinusoidal to a degree that will allow easy recognition of high fractional Lissajou patterns such as 53/4 or 52/5. Thus, exact measurements can be made of frequencies 1% or 2% apart in the audio spectrum, and up to 100 kc. With any conventional mixer system harmonics may be obtained for frequency calibration to 20 megacycles or higher, even though the wave form of the standard is sinusoidal.

POWER SUPPLY: The Standard operates from 115 volt 60 cycle power supply, and the power supply is regulated to minimize line voltage fluctuation effect.

MOUNTING: The Model 100A is available in either cabinet or relay rack mounting. The panel size is 19" x 10½" and the depth is 12".

When ordering specify if temperature control of the crystal is desired; otherwise, specify ambient temperature at which crystal frequency should be set.

HEWLETT-PACKARD CO.

395 PAGE MILL ROAD



PALO ALTO, CALIFORNIA

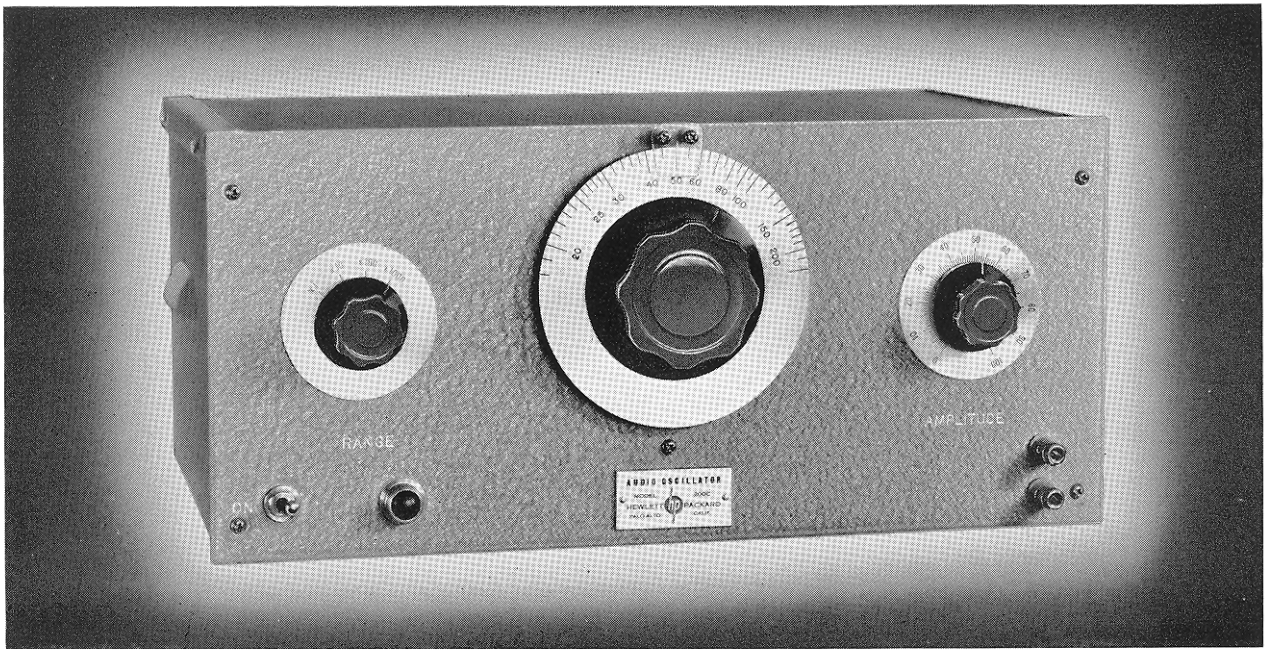

MODEL 200C



RESISTANCE-TUNED AUDIO OSCILLATORS

- *Low distortion*
- *Constant output*
- *Logarithmic scale*
- *No zero setting*
- *Small size*
- *High output*

USES: Resistance-Tuned Oscillators are suitable for almost every type of work. Their low distortion makes them particularly valuable in making distortion measurements on audio amplifiers, broadcast transmitters, and other equipment. They provide an excellent source of voltage for accurate bridge measurements. The output is sufficient to drive signal generators and other equipment requiring considerable power. Their wide frequency range also makes them suitable for work in the super-sonic region.

There are only three controls on the panel: the main frequency dial, the range selecting switch, and the output voltage control. The usefulness of Resistance-Tuned Audio Oscillators is increased because they are small in size and light in weight. Their extreme simplicity of operation will save valuable time in production testing, maintenance, and development work. The frequency drift is negligible even during the first few minutes of operation and consequently no zero adjustment is necessary. The constant output of these oscillators makes it easy to check the frequency response of apparatus quickly and accurately.

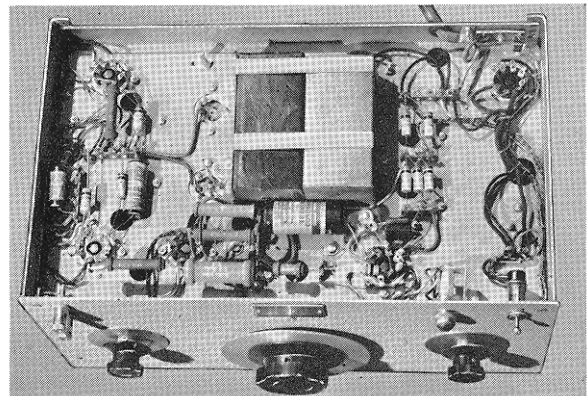

Arrangement beneath chassis gives good accessibility to all parts.

Top of chassis view showing main tuning condenser.

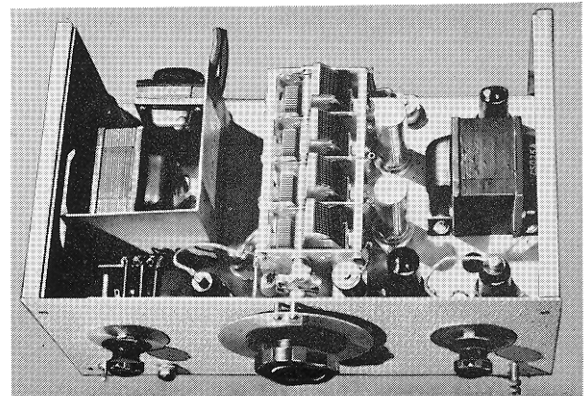

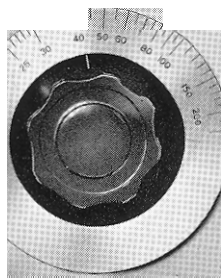

200B and 200C frequency control dial.

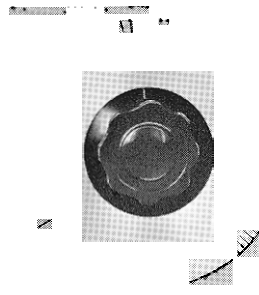

200D frequency control dial.

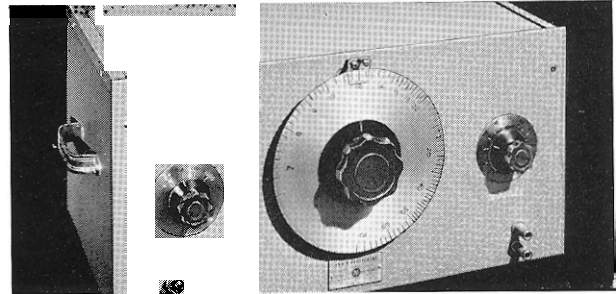

Model 200D

SPECIFICATIONS: The Hewlett-Packard oscillators are designed and built to give long, trouble-free service. High quality parts are used throughout, and each oscillator is subjected to rigid tests before shipment. Four standard models are available. The Models 200A and 200B have a transformer-coupled output amplifier which will deliver 1 watt into a matched load. The Models 200C and 200D have a resistance-coupled output amplifier to provide uniform output voltage over their wide frequency range. These oscillators are supplied in a relay rack mounting as the 200AR, 200BR, 200CR, and 200DR, respectively.

FREQUENCY RANGE:

Model 200A.....	35 cps to 35 kc
Model 200B.....	20 cps to 20 kc
Model 200C.....	20 cps to 200 kc
Model 200D.....	7 cps to 70 kc

CALIBRATION: The dial is calibrated directly in cycles for the lowest range. A switch selects the range and indicates the proper multiplying factor. Each range covers 180 degrees on the dial and so the equivalent scale length is from 20 to 30 inches on the various models.

	200A	200B
Range 1.....	35-350 cps.....	20-200 cps
Range 2.....	350-3500 cps.....	200-2000 cps
Range 3.....	3500 cps-35 kc.....	2000 cps-20 kc
	200C	200D
Range 1.....	20-200 cps.....	7-70 cps
Range 2.....	200-2000 cps.....	70-700 cps
Range 3.....	2000 cps-20 kc.....	700-7000 cps
Range 4.....	20 kc-200 kc.....	7000 cps-70 kc

STABILITY: Under normal temperature conditions the frequency drift is less than $\pm 2\%$ even including initial warm-up. Plus or minus 20% line voltage varia-

tions change the frequency less than $\pm 0.2\%$ at 1 kc. No zero setting is necessary on these oscillators.

OUTPUT: The Models 200A and 200B will supply one watt output into a matched resistance load of 500 ohms, 25 volts on open circuit. Special output impedances can be supplied on order.

The Models 200C and 200D will deliver 10 volts into a 1000 ohm load. The internal impedance of the output amplifier is about 50 ohms at 1000 cps.

FREQUENCY RESPONSE: The output voltage of the Models 200A and 200B is constant within plus or minus 1 decibel from 20 cps to 15 kc.

The output voltage of the Model 200C is constant within plus or minus 1 decibel from 20 cps to 150 kc. The output voltage of the Model 200D is constant within plus or minus 1 decibel from 7 cps to 70 kc.

DISTORTION: The total r.m.s. distortion contained in the wave-form of the various models is within the following limits: Models 200A, 200B, less than 1% distortion from 35 cps to 20kc. Model 200C, less than 1% distortion from 20 cps to 20kc. Model 200D, less than 1% distortion from 10 cps to 20 kc.

HUM VOLTAGE: The hum voltage is less than 0.1% of the maximum output voltage.

POWER SUPPLY: 115 volts—60 cycles—50 watts.

TUBES: Models 200A and 200B, 1 6J7, 1 6F6, 1 6F5; 1 6V6, 1 5Z4. Models 200C and 200D, 2 6J7, 1 6F6, 1 6V6, 1 5Z4.

MOUNTING: The cabinet models are mounted in an attractive steel cabinet finished in wrinkle grey.

The relay rack mounting fits the standard 19" relay rack with $\frac{3}{4}$ " spacing. The dust cover mounts on the chassis and is removable from the rear.

Model	Mounting	Length	Height	Depth	Weight
200A	Cabinet	16"	8"	9"	32#
200B	Cabinet	16"	8"	9"	32#
200C	Cabinet	16"	8"	9"	30#
200D	Cabinet	19"	8 $\frac{3}{4}$ "	11"	32#
200AR	Relay Rack	19"	7"	9"	35#
200BR	Relay Rack	19"	7"	9"	35#
200CR	Relay Rack	19"	7"	9"	35#
200DR	Relay Rack	19"	8 $\frac{3}{4}$ "	11"	37#

Data subject to change without notice.

HEWLETT-PACKARD CO.

395 PAGE MILL ROAD, PALO ALTO, CALIFORNIA

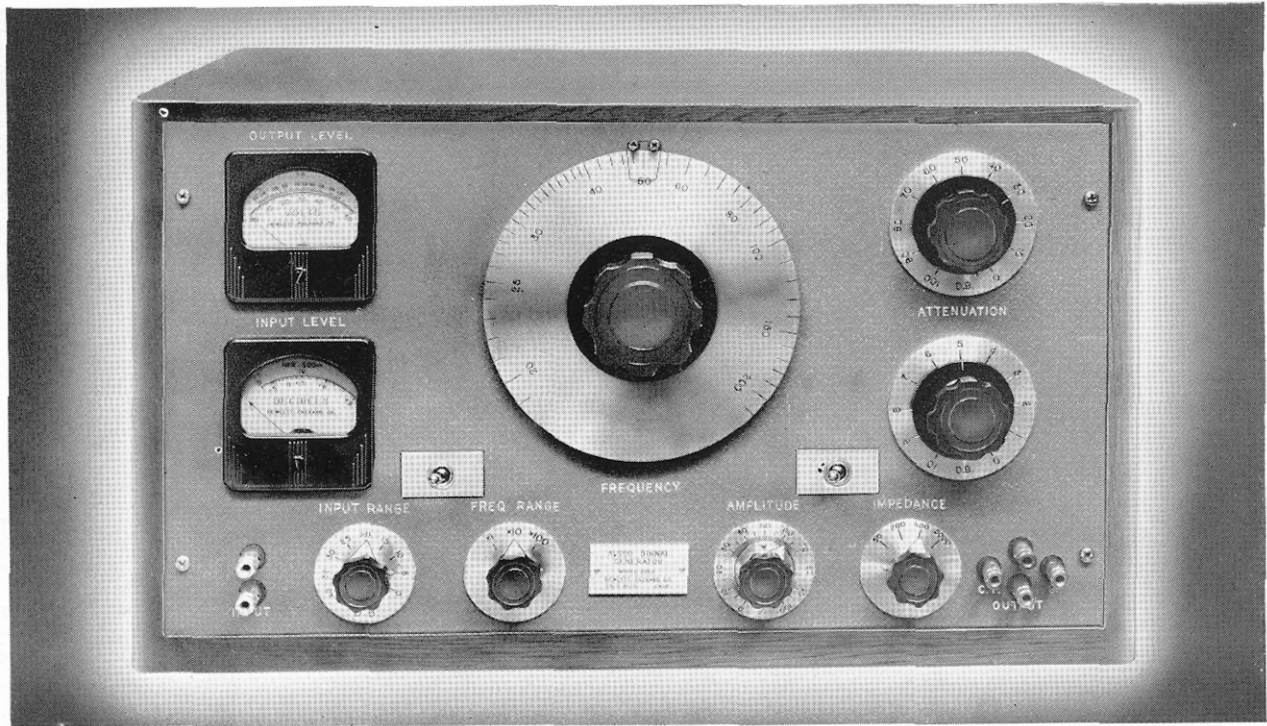

MODEL 205AG



AUDIO SIGNAL GENERATORS

MODELS 205A AND 205AG

- *Standardized frequencies and voltage instantly available*
- *Output impedances selected by switch*
- *Attenuation system provides 110 db. in 1 db. steps*
- *Five watts output with less than 1% distortion*
- *Frequency always accurate without zero setting*
- *Output meter calibrated in volts and decibels*
- *Separate input meter available for gain measurements*

USES: The Hewlett-Packard Audio Signal Generators are designed for time saving performance. The various features have been selected with the aim to make these instruments suitable for accurate and rapid measurement work. They are excellent for general laboratory applications because they supply a known voltage as well as a known frequency at the commonly used impedance levels. They are particularly suitable for gain measurements because no auxiliary apparatus is required. They provide an excellent source of voltage for distortion measurements because their waveform distortion is very small. The many new features make these instruments adaptable to numerous jobs in the audio frequency field.

DESCRIPTION: The Model 205A consists of a Hewlett-Packard resistance-tuned oscillator in combination with an output meter, attenuator, and an impedance matching system. The Model 205AG includes input meter for gain measurements.

The accompanying block diagram shows the arrangement of the various components in the system. The

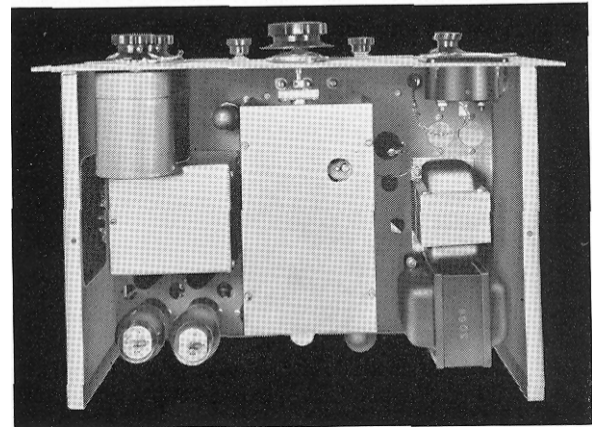

Views of bottom and top of 205A

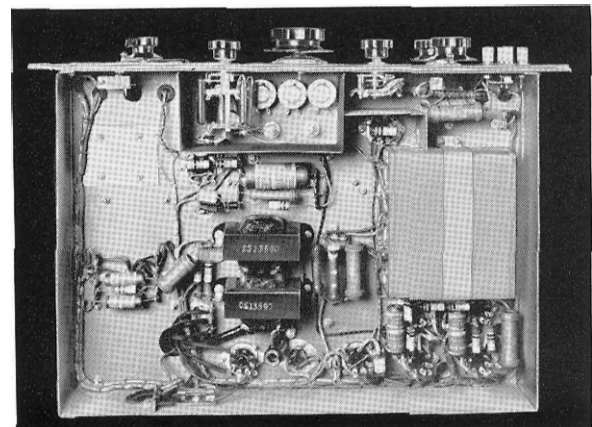

oscillator has a five-watt output which feeds directly into a 500 ohm line where the voltage is measured. The amplitude of this voltage can be set to any level up to plus 37 decibels above one milliwatt by means of the amplitude control on the oscillator. Following the meter are two attenuators, one providing 100 decibels in 10 decibel steps and the other providing 10 decibels in 1 decibel steps. From the output of the attenuators

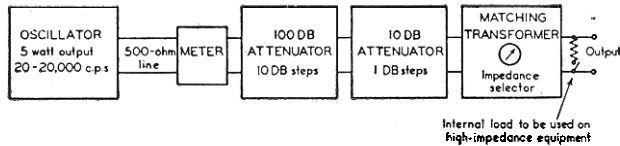

an impedance matching transformer is provided to match various impedances. The output transformer has the same insertion loss for all impedances and the output meter is arranged to read the output voltage at the output terminals with the system loaded. An internal load is provided so the attenuation system works correctly when there is no external load.

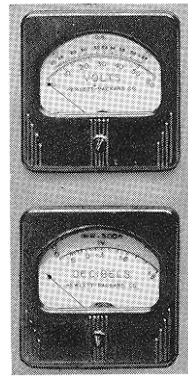

205AG input and output meters.

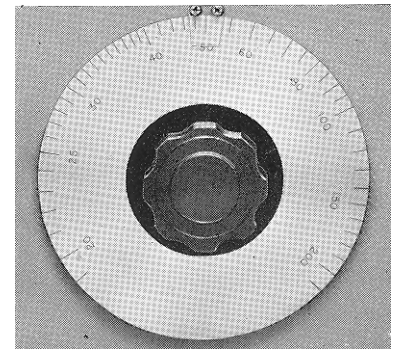

205A frequency control dial.

Every precaution has been taken to make these signal generators precision instruments. Special heavy mechanical construction has been used throughout to give assurance that the accuracy will be maintained in long, hard service.

SPECIFICATIONS

Model 205A

FREQUENCY RANGE: The frequency range is 20 cps to 20,000 cps.

CALIBRATION: The dial is calibrated directly in cycles for the lowest range, 20 cps to 200 cps. A switch selects the range and indicates the proper multiplying factor. Each range covers approximately 270 degrees on the 6½" main dial. Range 1 covers 20 cps to 200 cps; Range 2 covers 200 cps to 2,000 cps; and Range 3 covers 2,000 cps to 20,000 cps.

STABILITY: Under normal temperature conditions the frequency will drift less than 2% over long periods of time. Each range is provided with an internal adjustment so that 1% accuracy may be maintained if required.

OUTPUT: Five watts output will be delivered to a matched resistance load.

OUTPUT IMPEDANCES: Output impedances of 50 ohms, 200 ohms, 500 ohms, and 5,000 ohms are available. All are center tapped.

FREQUENCY RESPONSE: The frequency response of the system beyond the output meter is down 2.0 db. at 20 cps and 1 db. at 20,000 cps.

DISTORTION: The distortion is less than 1% at full output at all frequencies above 30 cps.

HUM LEVEL: The hum level is 60 db. below the output voltage or minus 90 db. below zero level, whichever is the larger.

OUTPUT METER: The output meter is calibrated directly in volts at 500 ohms and in db. above a 1 mw. level (50 volts and plus 37 db. full scale).

OUTPUT ATTENUATOR: The output attenuator provides 110 db. in 1 db. steps. It consists of a 100 db. attenuator with 10 db. steps and a 10 db. attenuator with 1 db. steps.

MOUNTING: The instrument is available in either relay rack or cabinet mounting, the panel size on either instrument is 19" x 10½". The cabinet models are mounted in attractive oak cabinets finished to harmonize with the panels. The panels are finished in gray wrinkle enamel with machine engraved designations.

Model 205AG

The Model 205AG is exactly similar to the Model 205A except it has an input meter for gain measurements.

INPUT METER: The input meter has a range of minus 5 db. to plus 49 db. based on a 1 mw. level and 500 ohms. The meter scale is calibrated from minus 5 db. to plus 9 db. and a multiplier switch adds from zero to 40 db. to the reading in 5 db. steps. The meter has an impedance of 5,000 ohms.

FREQUENCY RESPONSE: The input meter is compensated to have about 0.5 db. rise at 20 kc so that gain measurements with the Model 205AG are accurate to 15 kc and only about 0.5 db. in error at 20 kc. Prices and delivery information are available on request.

These data are subject to change without notice.

HEWLETT-PACKARD CO.

395 PAGE MILL ROAD



PALO ALTO, CALIFORNIA



MODEL 500A



ELECTRONIC FREQUENCY METER

- *Wide Range*
- *Good Sensitivity*
- *Excellent Accuracy*
- *Reading independent of line voltage*



The Model 500A Frequency Meter is designed to measure the frequency of an alternating voltage from 0 to 50 kc. It is useful in making frequency measurements in both laboratory and production work. In frequency measurement work at higher frequencies it can be used to measure the frequency difference between two radio frequency signals. It is particularly suited to crystal grinding work where it can be used to measure the frequency deviation from the standard quickly and accurately. The simplicity and accuracy of this instrument makes it useful in any electronic laboratory and invaluable in certain production testing applications.

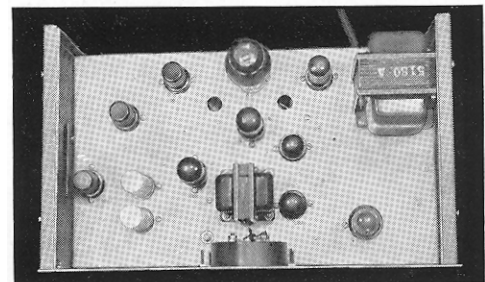

Views showing component parts on top and bottom of chassis.

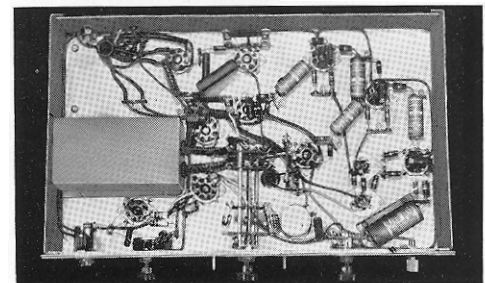

DESCRIPTION: The frequency meter consists of a wide band amplifier with a limiting circuit, and electronic switch, a constant current supply, a frequency discriminating circuit, and an output meter and rectifier. The input signal is amplified and used to switch the constant current source to alternate load resistors. The voltage developed across these resistors is applied to a condenser, and the output meter indicates the average value of the rectified charging current. The circuit is designed so that each pulse of charging current has the same average value, making the meter reading

proportional to the number of charges per second, and hence proportional to the frequency of the input signal. The reading is practically independent of the input voltage wave form, as normal wave form errors cannot affect the electronic switching operation. The regulated current source makes the reading independent of variations in input signal voltage and line voltage. A multiplier switch in the meter circuit provides ten convenient scale ranges. Provision is made for checking the calibration against power line frequency, and an adjustment is provided for changing the overall calibration if necessary.

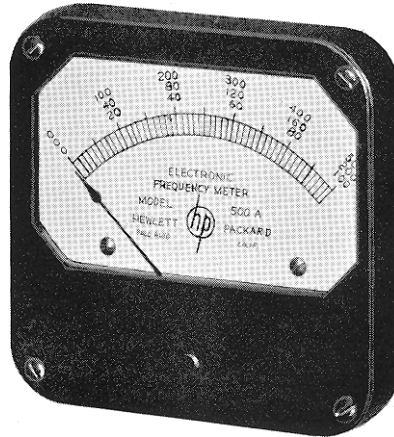

Easy to read calibrations

SPECIFICATIONS

FREQUENCY RANGE: 10 cycles to 50 kc, in ten ranges having full scale values of 50, 100, 200, and 500 cycles, and 1, 2, 5, 10, 20, and 50 kc.

INPUT: An input voltage of at least 0.5 volts is required and the input impedance is 50,000 ohms. Variation of the input voltage from 0.5 volts to 200 volts will affect the reading of the meter by not more than plus or minus 1%.

ACCURACY: The overall accuracy of the meter is plus

or minus 2% of full scale value. A line voltage variation of from 105 volts to 125 volts will affect the reading by not more than plus or minus 1%.

POWER SUPPLY: 105-125 volts, 60 cycles.

TUBES: 3-6SJ7, 2-6V6, 1-6L6, 1-6H6, 1-5Z4, 1-VR150/30.

MOUNTING: The instrument is available in either cabinet or relay rack mounting. The panel size is 8³/₄" x 19" and the depth is 12".

HEWLETT-PACKARD CO.

395 PAGE MILL ROAD



PALO ALTO, CALIFORNIA



VACUUM TUBE VOLTMETER

MODEL 400A



- *Wide voltage range*
- *Excellent accuracy*
- *Time saving stability*
- *High input impedance*
- *Good voltage sensitivity*
- *Large overvoltage capacity*

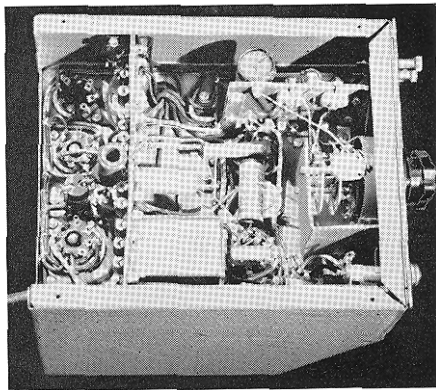

Circuit elements are rigidly mounted on Bakelite cards to assure dependability. View below shows tube arrangement on top of chassis.

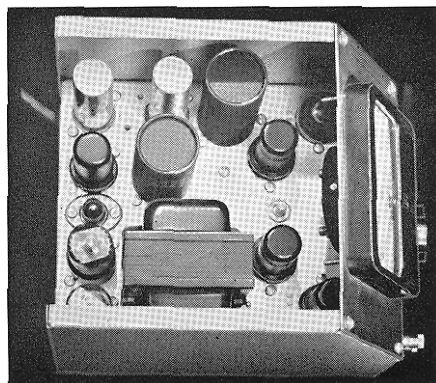

USES: The Model 400A Vacuum Tube Voltmeter sets a new standard of performance for voltage measurements in the audio, supersonic, and lower radio frequency region. Measurements up to 1 megacycle with this new instrument are as simple as measurements with the usual multi-range meter at d-c. Ordinarily no precautions whatsoever are required: turn-over effect and waveform errors are minimized because this meter responds to the average value of the full wave; there are no adjustments to make during operation; a large overload will not damage the instrument; and the input impedance is high enough so that it will not affect the circuit being measured.

The excellent characteristics of this meter make it invaluable for laboratory work in measuring amplifier gain, network response, output level. The sensitivity is sufficient to measure the hum level directly in many cases. The high voltage ranges are useful for measuring power circuit voltages and high frequency voltages in transmitting equipment. A decibel scale is provided to facilitate readings in cases where a decibel base is desired.

The simplicity of operation of the Model 400A will save valuable time in production testing because no time will be lost in adjusting the zero position or in making other adjustments during operation. The usefulness of this instrument is increased because of its wide frequency range. It is ideally suited not only for audio frequencies from 10 cps to 20 kc, but also for applications in carrier current work, in supersonics, in television and throughout the broadcast field.

DESCRIPTION: The Model 400A Vacuum Tube Voltmeter is a wide band feedback amplifier which operates a diode voltmeter of the average reading type. The circuit is independent of line voltage variations and tube characteristics to a high degree. A special input amplifier circuit is used to provide a high input impedance and also to allow the use of an accurate voltage divider to select the voltage range. The power supply is self contained, thoroughly filtered and electrostatically shielded from the primary voltage source.

The instrument is mounted in a metal cabinet finished in wrinkle grey. The meter scale is on a sloping panel to facilitate meter readings. The scale is calibrated in volts and decibels. Because of the design of the instrument reasonable overload voltages will not damage the meter movement.

The small size and light weight of this meter combine with its excellent characteristics to make it a real time saver in the laboratory or in the field.

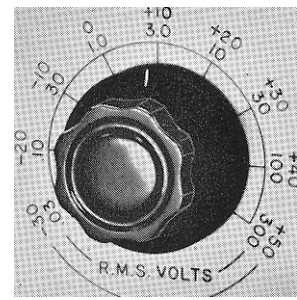

Range selection switch on 400A. Note both voltage and D. B. calibrations.

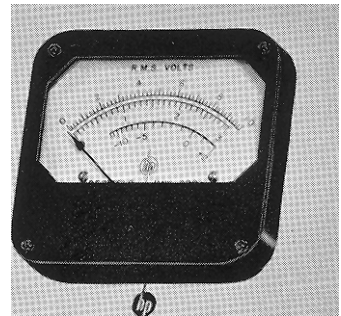

Meter face on 400A. Note both voltage and D. B. calibrations.

SPECIFICATIONS

VOLTAGE RANGE: A switch on the front panel selects nine voltage ranges having full scale sensitivities of .03 volts, 0.1 volts, 0.3 volts, 1.0 volts, 3.0 volts, 10.0 volts, 30.0 volts, 100 volts, 300 volts.

CALIBRATION: The meter is calibrated to read the r.m.s. value of a sinusoidal wave. The voltage scale is linear and a decibel calibration based on 1 milliwatt and 600 ohms is provided. The indication is in proportion to the average value of the full wave, thus waveform errors and turnover are minimized.

FREQUENCY RANGE: The frequency response of the meter is within 3% from 10 cps to 100 kc and within 5% to 1 MC.

ACCURACY: The over-all accuracy of the meter is 3% below 100 kc and 5% from 100 kc to 1.0 MC. Line voltage variations from 105 volts to 125 volts or changing tubes will affect the reading by less than 3% at all frequencies below 100 kc.

INPUT IMPEDANCE: The input impedance is equivalent to 1 megohm shunted by 16 uufd.

OVERVOLTAGE CAPACITY: Occasional overloads of 100 times normal will not damage the meter movement. Continuous or frequent overloads should be avoided.

POWER SUPPLY: The instrument operates from 115 volts 60 cps.

MOUNTING: The meter is mounted in a steel cabinet finished in wrinkle grey. The front panel is heavy brass finished in satin chrome plate with photo-etched designations. The cabinet is 7½ inches wide, 8 inches high, and 9 inches deep. A leather handle is provided at the top of the cabinet.

SHIPPING WEIGHT: 20 pounds.
Data subject to change without notice.

HEWLETT-PACKARD CO.

395 PAGE MILL ROAD



PALO ALTO, CALIFORNIA



HARMONIC WAVE ANALYZER

MODEL 300A

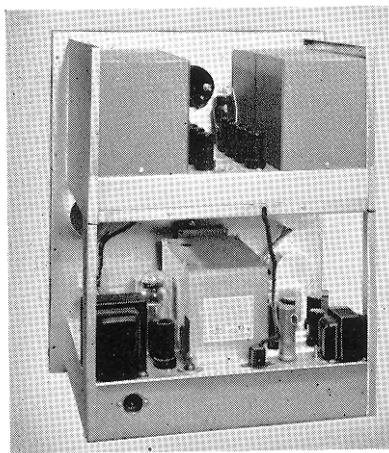

Above: A view from rear of 300A.

Below: A positive dial control.

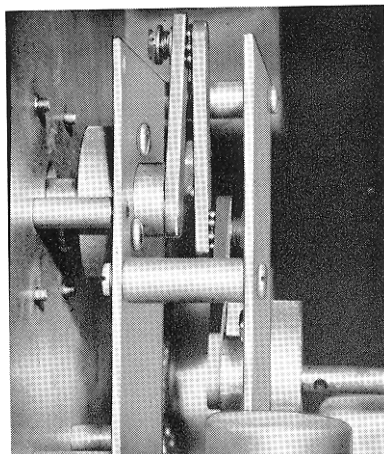

A New Wave Analyzer Featuring

- *Linear meter scale*
- *Simplified operation*
- *Improved stability*
- *Variable selectivity*
- *Wide voltage range*

USES: The many new features of the Model 300A Harmonic Wave Analyzer make it an excellent instrument for both laboratory and production work where accurate and rapid measurement of individual components of a complex wave is required.

The maximum selectivity is sufficient for measurement of harmonics of frequencies as low as 30 cycles. Furthermore, the selectivity can be varied over a wide range by means of a unique selective amplifier developed in the Hewlett-Packard laboratories. With this variable selectivity feature, measurements at higher frequencies can be made more rapidly, yet with no sacrifice in accuracy.

Variable selectivity makes this analyzer useful for many applications where a constant selectivity would be unsuitable. For example, variable selectivity is required in measuring distortion of sound recorded on film, disk, or other cases where there may be a small amount of frequency modulation. It may be used in integrating the noise spectrum for acoustic measurements or for other purposes where a wider pass band gives a more representative integration. In many other ways the usefulness of the Model 300A is increased, because the selectivity can be varied at will.

The wide voltage range of the Model 300A covers the values encountered in nearly every application. The meter, which is fully protected against overloads, is linear, and the various scales have ample overlap for accurate readings. A built-in calibrating system is provided to standardize the voltage measurements.

The accuracy, stability, flexibility, and ease of operation of this new wave analyzer assure time-saving performance for any application requiring a frequency-selective voltmeter.

DESCRIPTION: The Model 300A is a frequency-selective voltmeter of the heterodyne type. It consists of a variable local oscillator which modulates the unknown voltage to produce a constant frequency which is equal to the difference between the local oscillator frequency and the unknown frequency that is being measured. This constant difference frequency is passed through a selective amplifier, the output voltage of which is then proportional to the magnitude of the unknown voltage. A meter is placed in the output of the selective amplifier to measure the magnitude of the voltage.

The local oscillator is of the resistance-tuned type which provides stability, accuracy of calibration, and freedom from magnetic fields. A balanced modulator is used to eliminate the local oscillator frequency and to insure low cross-modulation products. The selective amplifier consists of four tuned circuits in which the effective Q is controlled by feedback. This amplifier has the unique characteristic that the selectivity may be varied over a wide range without appreciably affecting the gain of the amplifier.

On the front panel are the main frequency selecting dial, an incremental frequency dial for fine adjustment, variable selectivity control, meter, range selectors, and input control.

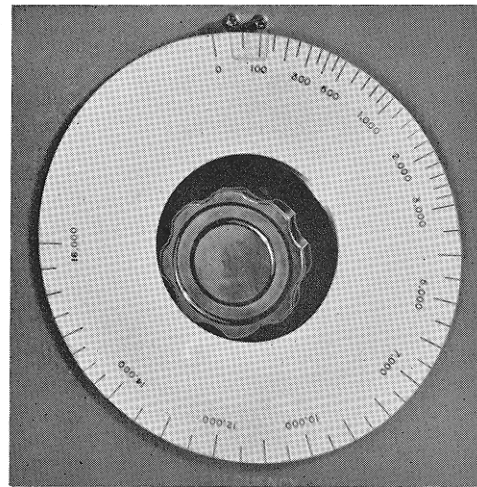

Close-up of main tuning dial. Direct reading.

At the bottom of the main panel are the balancing and calibrating controls and a calibrating meter which is used to check the sensitivity against the line voltage. These controls are mounted in a small, recessed compartment which may be closed during normal operation.

The instrument has been designed throughout for ease of operation and for accuracy which will be maintained over long periods of time.

SPECIFICATIONS

FREQUENCY RANGE: The frequency range is from 30 to 16,000 cps. The frequency calibration is within 3%.

VOLTAGE RANGE: There are four input voltage ranges having maximum values of 0.5 volts, 5 volts, 50 volts, and 500 volts. In addition, a meter multiplier divides each voltage range into full scale meter readings of 500, 250, 100, 50, 25, 10, 5, 2.5, and 1. Thus full scale meter readings can be obtained on from 1 mv to 500 v. The meter is linear and is fully protected against overloads.

SELECTIVITY: The selectivity can be varied by means of a control on the front panel. At the maximum selectivity setting, the response is down 3 db. at 3 cycles, 10 db. at 8 cycles, 40 db. at 30 cycles, and 60 db. at 50 cycles from maximum response. This selectivity can be varied continuously until at the minimum selectivity the band width required for a given attenuation is six times that at the maximum selectivity setting. Thus, at minimum selectivity the response is down 3 db. at 18 cycles, 10 db. at 48 cycles, 40 db. at 180 cps, and 60 db. at 300 cycles from maximum response. The variable selectivity control is calibrated in the half band width at which the response is down 40 db.

VOLTAGE ACCURACY: The over-all voltage accuracy is $\pm 5\%$, provided adjacent harmonics are within limits determined by the selectivity. The characteristics of the metering circuit are such that measurement of a particular component may be made with 5% accuracy, provided unwanted voltages are attenuated to less than $\frac{1}{3}$ of the voltage being measured. Thus, with maximum selectivity a 1% second harmonic of a 40 cycle voltage may be measured with 5% accuracy.

The residual modulation products are suppressed by at least 65 db. Hum is at least 75 db. below maximum input voltage on any of the four input ranges.

INPUT IMPEDANCE: The input impedance is 200,000 ohms. The input circuit includes a potentiometer which is set to maximum for voltage measurements.

POWER SUPPLY: The instrument contains a voltage regulated power supply which operates from 110 volts, 60 cycles.

MOUNTING: The Model 300A is mounted in an attractive oak cabinet to harmonize with the panel which is finished in wrinkle grey with machine engraved designations. A relay rack model is also available and is designated as the Model 300AR.

Model	Mounting	Length	Height	Depth	Shipping Weight
300A	Cabinet	21"	24 $\frac{1}{2}$ "	13"	180#
300AR	Relay Rack	19"	22 $\frac{3}{4}$ "	12"	170#

These data are subject to change without notice.

HEWLETT-PACKARD CO.

395 PAGE MILL ROAD, PALO ALTO, CALIFORNIA

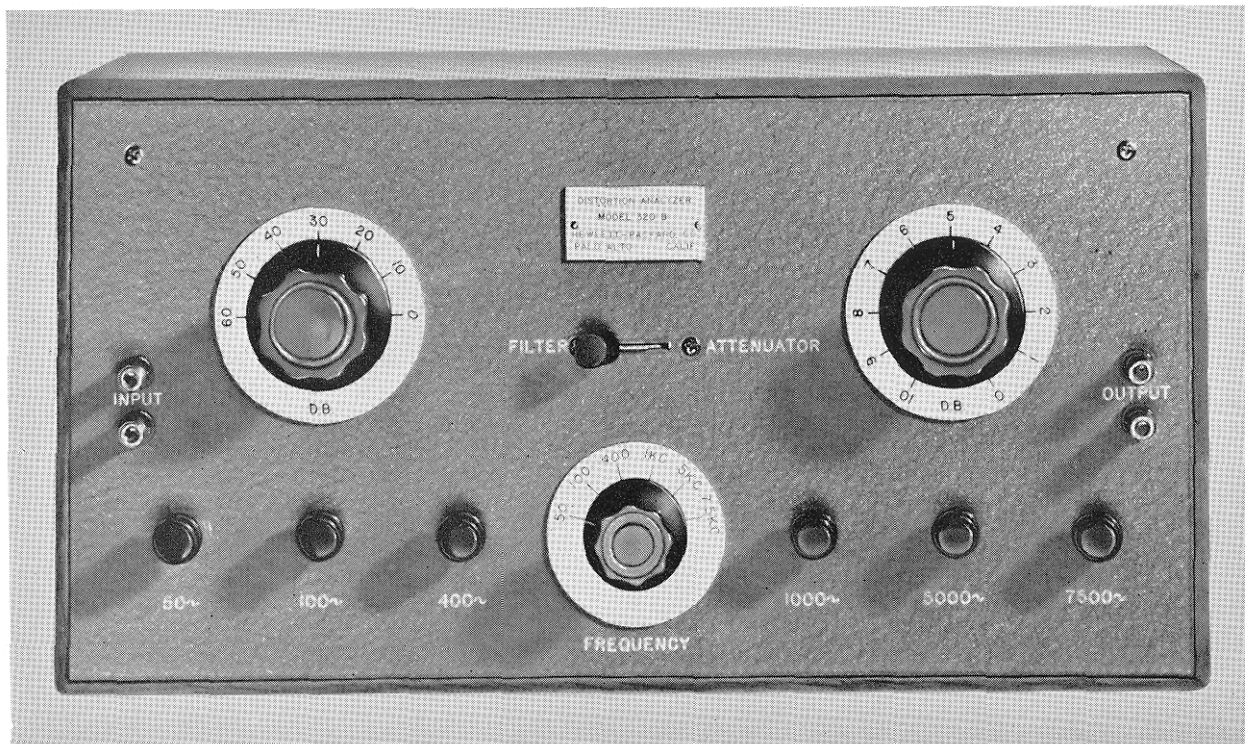

THE MODEL 320B

DISTORTION ANALYZER

- A new instrument for distortion measurements
- Shows type of distortion as well as amount
- Standard models for measurements at two or six frequencies

- Any frequencies from 50 to 10,000 cycles available
- Saves time in development and production testing

USES: The Model 320 Distortion Analyzer is a simple and convenient device for studying and measuring the harmonic distortion in audio frequency apparatus. It is particularly suitable for development work because with it the character and type of distortion can be determined at the same time the distortion is being measured. It is excellent for production work because it is easy to operate and provides a rapid and accurate check for normal operation.

The Model 320 is essentially a comparison device used to compare the distortion content of the wave with the fundamental voltage. When this comparison is made with a cathode ray oscilloscope the type of distortion can be observed. The various order harmonics will show up on the oscilloscope pattern, the hum voltage and noise voltage will appear, and a great deal of information about the voltage being analyzed can be obtained. In this way the Model 320 is a valuable instrument not only when used alone but also when used with other equipment which measures the total r.m.s. distortion directly.

DESCRIPTION: The distortion analyzer consists of two fundamental elimination filters, one for measurements at 400 cycles and one for measurements at 5,000 cycles, and a calibrated attenuator. With the voltage to

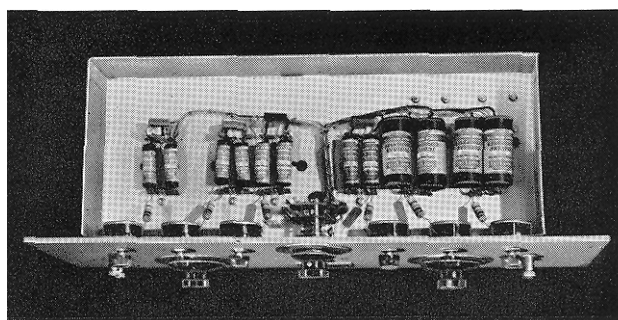

Views showing bottom and top of 320B chassis.

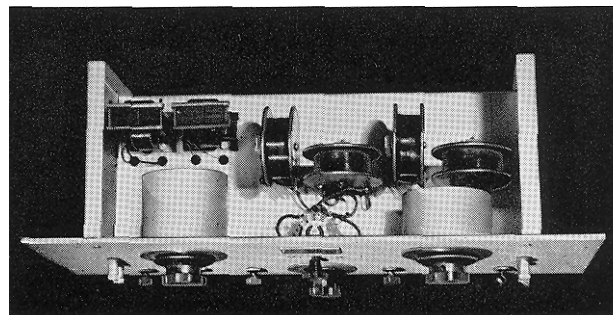

be analyzed adjusted to the proper frequency the fundamental is eliminated completely. The residual voltage containing the harmonics can then be observed with an oscilloscope or measured with a sensitive meter. When the frequency has been adjusted so the fundamental is eliminated, the elimination filter is switched out and a calibrated attenuator is introduced.

MEASUREMENTS: With the proper adjustment, the setting of the attenuator on the instrument gives directly the amplitude of the harmonic voltage in decibels below the fundamental. When an oscilloscope is used for the detector, measurements of the harmonic voltage require some exercise of judgment. The residual harmonic voltage will contain sharp peaks in many cases. These peaks contain very little energy and this should be taken into account in estimating the r.m.s. or average value of the residual harmonic voltage.

If more accurate measurements are desired a meter may be used in place of the oscilloscope or in conjunction with it. With such a meter the distortion measure-

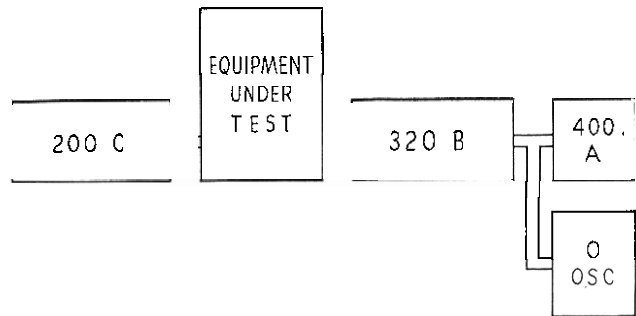

ments may be made with as good accuracy as can be obtained with the more expensive distortion meters.

For distortion analysis an oscilloscope should be used as the detector. As the frequency is adjusted to eliminate the fundamental, the second, third, and higher order harmonics will appear superposed on the fundamental voltage, and from the trace obtained the relative importance of these components can be determined.

SPECIFICATIONS

FREQUENCY RANGE: The Model 320A is designed for measurements at 400 and 5000 cps. The Model 320B is designed for measurements at 50, 100, 400, 1000, 5000, and 7500 cps. Filters for other frequencies can be supplied on special order.

INPUT IMPEDANCE: The input impedance is at least 20,000 ohms. A bridging transformer may be used to increase the input impedance.

DISTORTION RANGE: The filter circuits will provide more than 60 db of attenuation of the fundamental. Distortion values as low as 0.1% of the fundamental may be measured with a detector of sufficient sensitivity.

DETECTOR SENSITIVITY: The sensitivity of the instrument is determined by the detector. The detector should give a readable indication on 0.1% of the fun-

damental if harmonics of 0.1% are to be measured. The detector need not be calibrated because it is used for comparison only. The usual oscilloscope with a one stage amplifier is sufficiently sensitive to measure 0.3% of a 30 volt fundamental. For proper operation of the instrument the input impedance of the detector must be 100,000 ohms or greater. An amplifier may be used between the instrument and the detector to increase the sensitivity. The only requirements on such an amplifier are that it must pass the highest harmonic which is of interest and that it have a high impedance input. It need not be free from distortion otherwise.

MOUNTING: The Model 320A and 320B are mounted in an attractive oak cabinet with the panel finished in wrinkle grey. The Model 320AR and 320BR fit the standard 19" relay rack with 3/4" spacing. The panels are finished in wrinkle grey with machine engraved designations.

Model	Mounting	Length	Height	Depth	Weight
320A	Cabinet	12"	8"	6"	8#
320AR	Relay Rack	19"	5 1/4"	5 1/2"	8#
320B	Cabinet	16"	8"	6"	15#
320BR	Relay Rack	19"	7"	10"	20#

Data subject to change without notice.

HEWLETT-PACKARD CO.

395 PAGE MILL ROAD  PALO ALTO, CALIFORNIA

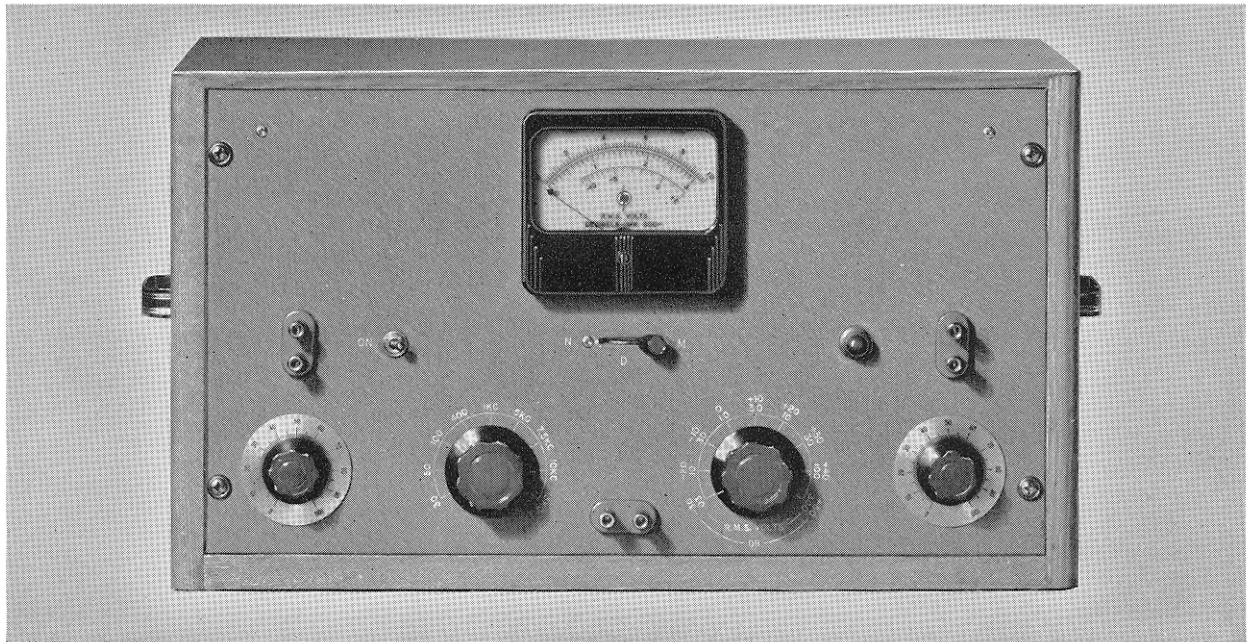

MODEL 325B

NOISE AND DISTORTION ANALYZER

The Model 325B combines a vacuum-tube voltmeter with a set of fundamental elimination filters for general purpose measurements of total harmonic distortion, noise and voltage level.

USES: The Model 325B provides a new approach to the problem of audio frequency measurements. The instrument can be used as a voltmeter for measuring voltage level, power output, amplifier gain, and in making all of the other measurements for which a high impedance voltmeter with a wide frequency range is necessary. Sufficient sensitivity is available in the Model 325B to measure noise and hum level in audio frequency equipment such as amplifiers and broadcast equipment. With the addition of a detector, noise level in the carrier output of transmitting equipment can be measured.

A set of fundamental elimination filters is included in the instrument to measure total harmonic distortion at nine specific frequencies. These are the frequencies recommended by the FCC for measurements on frequency modulation as well as amplitude modulation equipment. On special order, filters for other frequencies from 30 cps to 20KC can be supplied. The amplifier and voltmeter section is flat from 10 cps to 100KC so that harmonics as high as the 5th of 20KC will be correctly indicated.

The Model 325B will meet the requirements of the most exacting production test problem on audio frequency equipment and when combined with a *-hp-* resistance-tuned Oscillator all of the measurements usually required on audio equipment can be made quickly and accurately with a minimum of additional equipment.

DESCRIPTION: The Model 325B consists of three separate sections, an input amplifier, a set of frequency elimination filters, a vacuum-tube voltmeter. A voltage

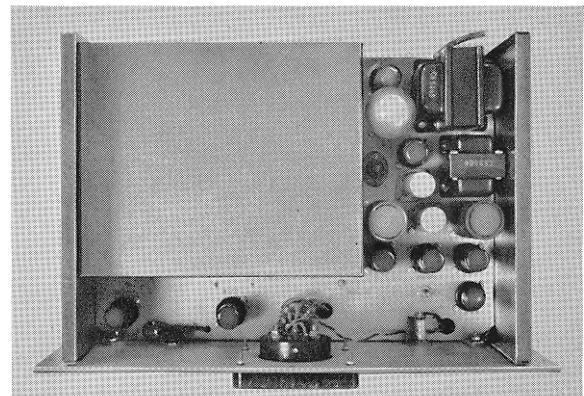

View showing arrangement of components on chassis.

Wiring is located below chassis for accessibility.

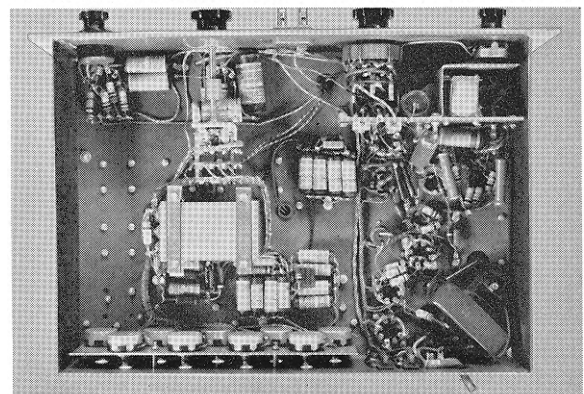

regulated power supply is built into the instrument to minimize the effect of line voltage fluctuations.

The input amplifier has a gain which is set by feedback to exactly 20db. This amplifier can be connected directly to the voltmeter section or it can be connected to the voltmeter through the elimination filters. This provides a high input impedance for distortion measurements and additional sensitivity for hum and noise measurements. A potentiometer is provided at the input for convenience in setting level.

The elimination filters are of the bridged T type for which the frequency to be analyzed must be variable over a range of 10%. When the frequency is properly set the fundamental elimination is almost complete so that distortion as low as 0.1% can be measured with good accuracy. Special precautions have been taken to permit good accuracy in distortion measurements even at 20KC.

The vacuum-tube voltmeter section is a two stage amplifier with feedback to insure stable operation. It is identical with the Model 400A voltmeter except the frequency range is limited to 100KC. Terminals are provided at the meter output for waveform observations with an oscilloscope.

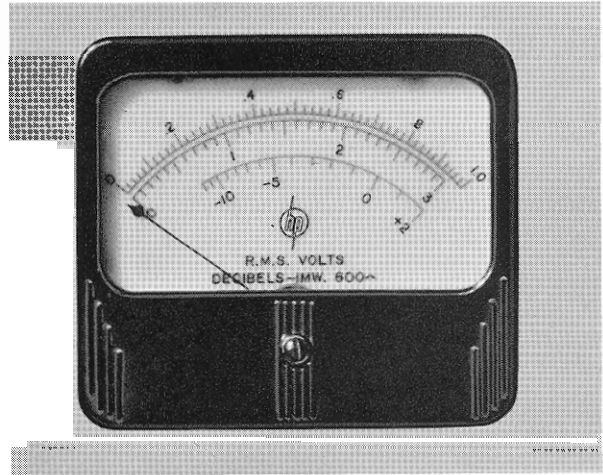

Voltmeter Face. Note both voltage and D. B. calibrations.

The multitude of ways in which this instrument can be used make it almost indispensable for laboratory, production test, or maintenance applications in the audio frequency field.

SPECIFICATIONS

SENSITIVITY: The Model 325B will give full scale indication on a distortion level which is 1% of the fundamental. Measurements to 0.1% may be made with good accuracy.

The instrument will give a full scale indication on hum and noise which is 0.01% of the signal. The full scale sensitivity is 3.0 millivolts or 50db below 1 mw on 600 ohms. Satisfactory readings to 70db below zero can be made. The over-all gain from the input terminals to the oscilloscope terminals is 75 db.

VOLTMETER RANGE: Nine voltage ranges are provided with full scale sensitivities of .03, .10, .30, 1.0, 3.0, 10, 30, 100, 300. The ranges are also calibrated in db and the range multiplier changes the sensitivity in steps of exactly 10. db. Zero level is 1 mw across 600 ohms.

VOLTMETER ACCURACY: The over-all accuracy of the unit for voltage measurements is 3%. Line voltage variations from 105 volts to 125 volts or changing tubes affects the reading by less than 3%.

VOLTMETER FREQUENCY RESPONSE: The frequency response of the meter including the input amplifier is within 3% from 10 cps to 100 KC.

FILTER FREQUENCY: Filters are provided for the following frequencies:

30 cps, 50 cps, 100 cps, 400 cps, 1000 cps,
5000 cps, 7500 cps, 10,000 cps and 15,000 cps.

These frequencies are set to $\pm 5\%$ of specified value.

DISTORTION MEASUREMENT ACCURACY: The filters are designed to eliminate the fundamental by more than 60 db and to attenuate the second and all

higher harmonics by less than 5%. Distortion measurements in general will be accurate with $\pm 3\%$ for distortion levels above 0.5%. When the distortion is largely second harmonic the accuracy will be $\pm 5\%$ for frequencies above 7.5KC.

NOISE MEASUREMENT ACCURACY: The accuracy of noise and hum measurements is essentially the same as the accuracy of voltage measurements. The measured value is the average value of the full wave.

INPUT IMPEDANCE: The impedance at the input amplifier terminals is approximately 200,000 ohms shunted by approximately 24 uufd. The input impedance at the meter terminals is 1 megohm shunted by approximately 32 uufd.

GENERAL: The Model 325B is complete with all necessary power supplies for operation from 115 volts 60 cycles. The various parts of the unit are arranged for maximum flexibility so they can be used separately if desired. A plug is supplied to connect an oscilloscope across the metering circuit so that observations of the residual distortion may be made if desired. The indicating meter is a 4-inch square type with a large scale for ease of reading. The meter and various range switches are calibrated in both volts and decibels. In general the instrument is designed for accuracy and ease of operation.

MOUNTING: The unit is mounted in an attractive oak cabinet with the front panel 19 inches by 10 1/2 inches. Complete shielding is provided against pickup from either 60 cycle or r. f. fields of reasonable magnitude. The panel is finished in wrinkle grey enamel with all controls and ranges clearly marked.

HEWLETT-PACKARD CO.

395 PAGE MILL ROAD



PALO ALTO, CALIFORNIA

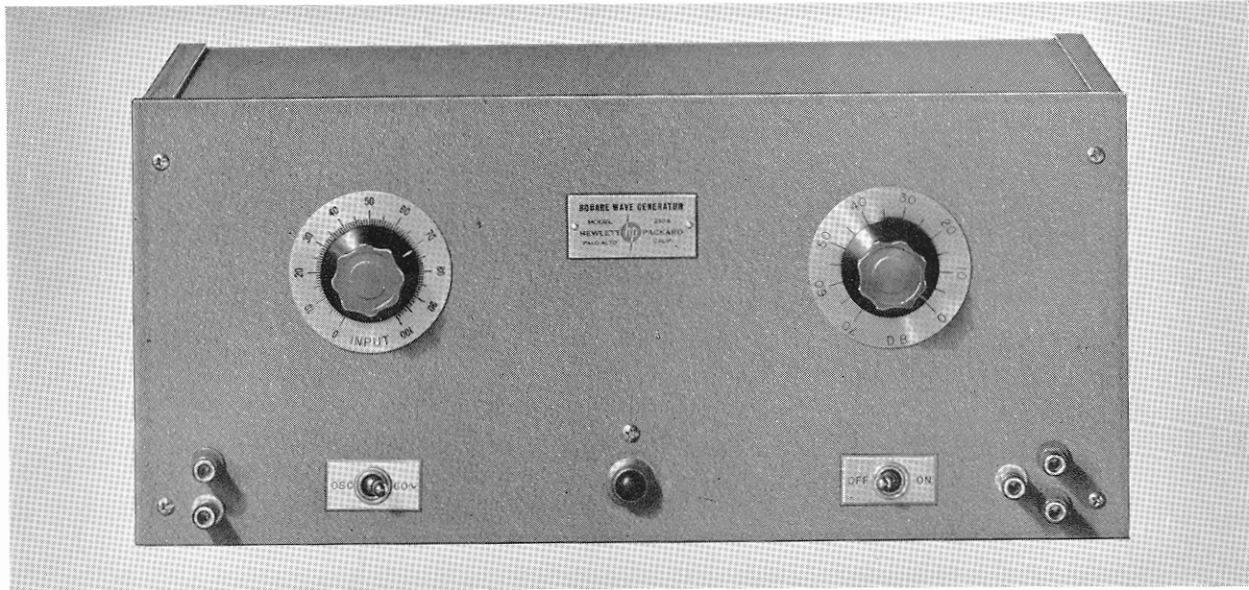

MODEL 210A



SQUARE WAVE GENERATOR

The Model 210 square wave generator is a new instrument which is extremely useful in both production testing and development work. It provides a new approach to the problem of measuring the characteristics of audio frequency equipment. This generator will save valuable time in production testing because one or two observations will check the frequency response of apparatus where heretofore a large number of observations were necessary. This new instrument is an important tool for development work because it will show up phase shift and transient effects, both of which are rather difficult to study by other methods.

USES: When a square wave is applied to an amplifier the top of the wave will show distortion if the frequency response of the amplifier does not extend to at least one tenth of the applied frequency. Likewise the sides of the wave will be distorted if the response of the amplifier does not extend to at least ten times the frequency of the square wave applied. Thus one observation with a square wave applied to an amplifier will check a wide frequency range, a range of 100 to 1 or even more. This is extremely important because once the proper criterion has been established a production test can be set up with one or at the most two observations with a square wave.

A square wave may also be used to study phase shift effects in an amplifier. An amplifier will not reproduce a square wave faithfully unless both the amplitude and phase shift characteristics are correct. Thus if the amplitude response is known to be good, phase shift effects can be determined by a square wave observation.

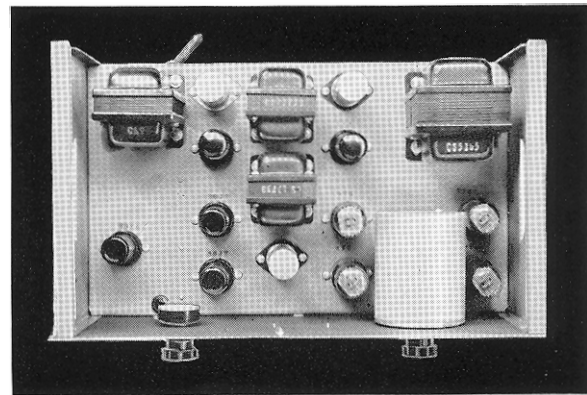

Views showing arrangement of components on chassis.

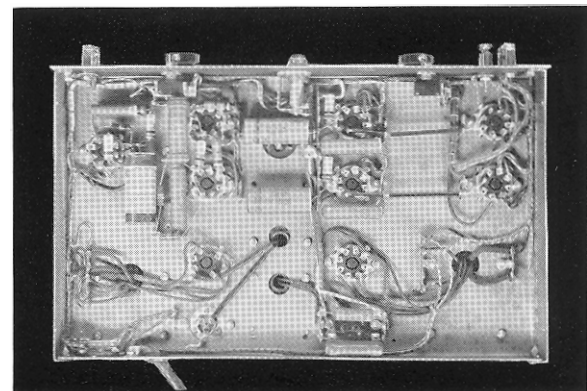

Peaks or deficiencies in amplification of an amplifier can be readily detected with a square wave generator. Amplification peaks appear as damped oscillations on top of the amplified square wave and these peaks can be measured in both frequency and amplitude with a given observation. Deficiencies in amplification at some part of the amplification band have the same appearance except for phase displacements in the damped oscillations.

A square wave is also very useful in determining the transient response of networks. Time constants of R-C circuits can be easily observed, damped oscillations of resonant circuits can be checked, and the transient behavior of complicated networks can be studied by the application of a square wave to the networks and observing the voltage or current with an oscilloscope.

SPECIFICATIONS

FREQUENCY RANGE: The output of the generator is square within 1% over the frequency range from 20 cycles to 10,000 cycles. The time for the voltage to rise to 90% of maximum is approximately 1 microsecond, thus a reasonably square wave can be obtained even at 100 kilocycles.

OUTPUT VOLTAGE: The output voltage is 50 volts peak to peak open circuit. The output impedance is 1000 ohms balanced to ground.

OUTPUT ATTENUATOR: A 75 db. attenuator is provided in the output with 5 db. steps. The frequency response of the attenuator is sufficiently wide so that the output wave shape is not affected even at the highest frequencies.

INPUT VOLTAGE: The generator may be driven from any convenient source of alternating voltage or it

may be internally synchronized to the power line frequency. A driving voltage of two volts is required and the input impedance is 25,000 ohms.

MOUNTING: The Model 210A is mounted in an attractive steel cabinet 15" long, 7" high, and 9" deep finished in wrinkle grey. The panel is grey baked enamel with machine engraved designations. The model 210AR is mounted in a relay rack assembly with a 19" by 7" panel and is 8" deep. The dust cover is removable from the rear and the binding posts may be supplied either on the panel or at the rear of the assembly.

POWER SUPPLY: The generator is provided with a built-in power supply to operate from 110 volts 50 or 60 cycles. It requires approximately 50 watts. Data subject to change without notice.



HEWLETT-PACKARD CO.

395 PAGE MILL ROAD, PALO ALTO, CALIFORNIA



Warranty

Hewlett-Packard Company warrants each instrument manufactured by them, to be free from defects in material and workmanship. Their obligation under this Warranty being limited to servicing or adjusting any instrument returned to their factory for that purpose, and to making good at their factory any part or parts thereof, which shall, within one year after making delivery to the original purchaser, be returned to them with transportation charges prepaid, and which on their examination shall disclose to their satisfaction to have been thus defective.

Hewlett-Packard reserves the right to make changes in design at any time without incurring any obligation to install same on units previously purchased.

This Warranty is expressly in lieu of all other obligations or liabilities on the part of Hewlett-Packard, and Hewlett-Packard neither assumes nor authorizes any other person to assume for them any liability in connection with the sales of Hewlett-Packard instruments.